

To Customers

Thank you very much for using our FM VHF/UHF Two Way Radio. This radio of modern design is reasonable structure with stable functions. It is designed to meet customer's needs for the high quality with easy operation and perfect capability. We believe you are pleased with the finished shape and the reasonable price.

This manual is suitable for using the model of PX-777 Plus

Contents

Maintenance	1
Features	1
Accessories and optional	2
Instruction manual	3-4
Basic operation	5-9
Operation	10-15
Self-Programming mode	16-18
Enclosed chart	19
Specification	20
Troubleshooting Guide	21

UNPACKING AND CHECKING EQUIPMENT

Carefully unpack the radio. We recommend that you identify the items listed in the following table before discarding the packing material. If any items are missing or have been damaged during shipment, file a claim with the carrier immediately.

Supplied Accessories

ITEMS	QUANTITY
Radio	1
Antenna	1
Battery	1
Rapid Charger	1
Belt Clip	1
Users's Manual	1

Optional Accessories

ITEMS
Earphone
Microphone
Connecting cable
Programmable software

Maintenance

Your Two Way Radio is an electronic product of exact design and should be treated with care .The suggestions below will help you to fulfill any warranty obligations and to enjoy this product for many years.

- Do not attempt to open the unit. Non-expert handling of the unit may damage it.
- When using regulated power supply, take notice of power voltage must be between 6V and 8V to avoid damaging the unit.
- Do not store the Radio under the sunshine or in hot areas. High temperatures can shorten the life of electronic devices, and warp or melt certain plastics.
- Do not store the Radio in dusty, dirty areas
- Keep the Radio dry. Rainwater or damp will corrode electronic circuits.
- If it appears that the Radio diffuses peculiar smell or smoke, please shut off its power immediately and take off charger or battery in the Radio, then contact with PUXING agency.
- Do not transmit without antenna.

Feature

- VHF5W/UHF4W Output power
- 128 groups of memory channels.
- 25KHz/12.5KHz Channel spacing compatible
- Automatic Numbering Identification (ANI) code
- Built-in Voice Operate Transmit (VOX) function.
- All channels scan and priority channel scan
- Scrambler
- Three color LCD backlight adjustable
- Emergency alarm
- Programmable by pc with software
- 50 CTCSS and 104 DCS Normal/Inverted selectable
- Time-out Timer (TOT)
- Busy channel lockout
- 2 tone/5 tone code

Accessories and optional

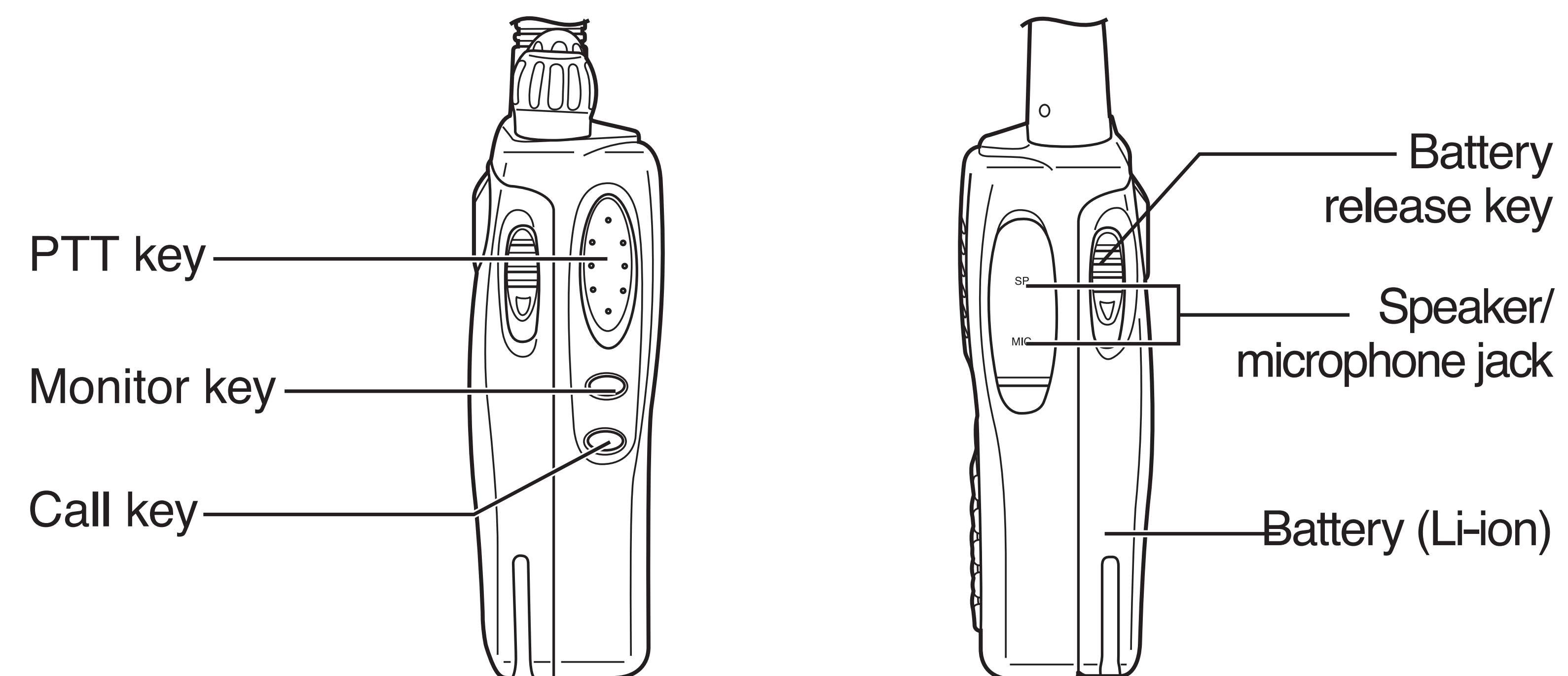
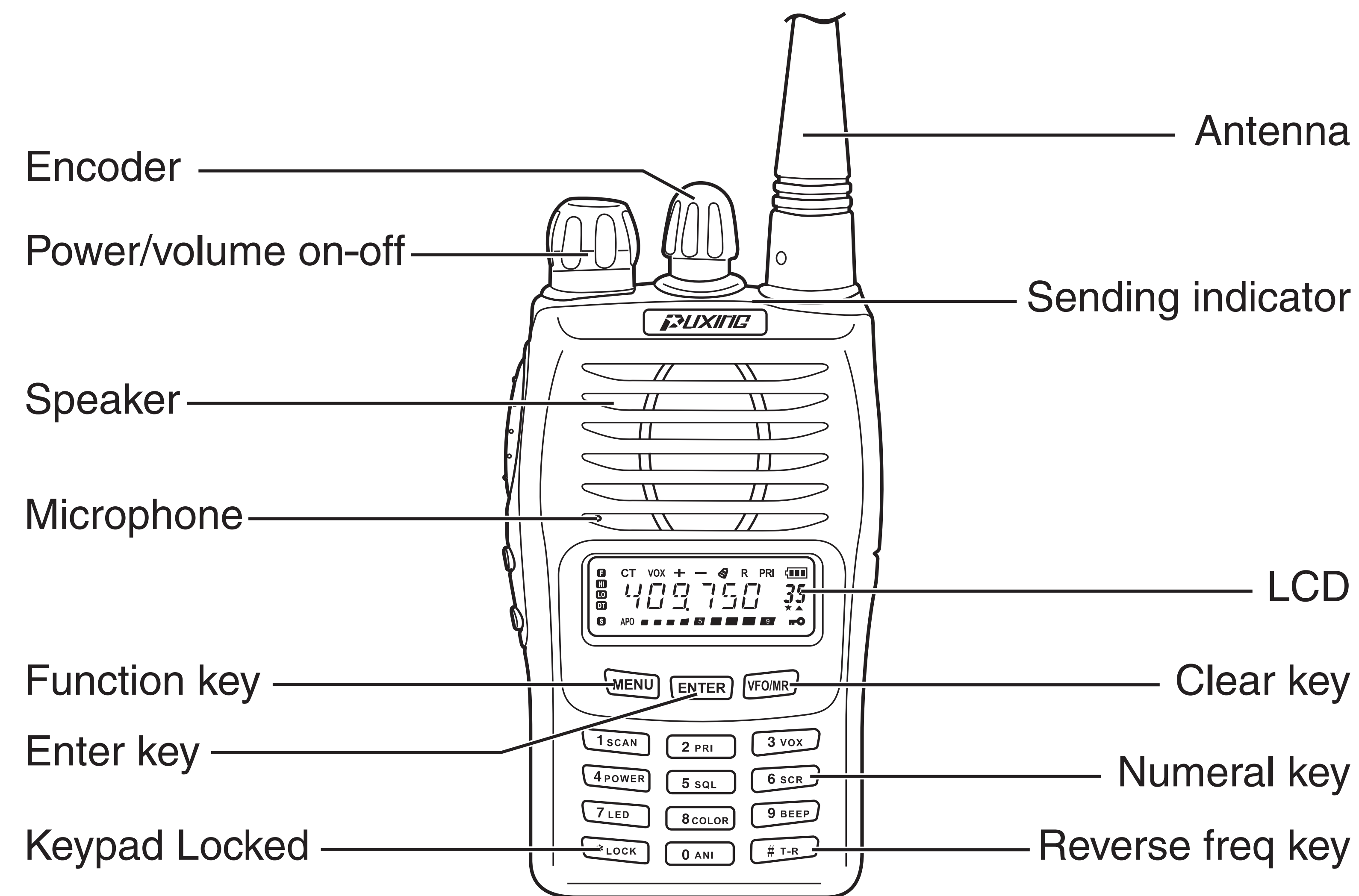

Instruction manual

Key, Knob, Switch, Indicator

■ Power/volume On-off	For opening and closing power, and control volume.
■ Sending indicator	Press PTT switch and it glows, which indicates talking is in sending status.
■ Busying indicator	When monitor key and squelch are opened,  shows on the LCD which means the radio is in busying status.
■ PTT key	Switch in sending and receiving signal.
■ MON (monitor) Key	Hold down this key in receiving and it can monitor the case in working channel, busying indicator lights after holding down monitor key.
■ Call key	Call to your partner
■ VFO/MR	For returning key and other function.

Socket and connector

■ SMA Connector	For connecting attached antenna
■ Speaker/microphone jack	If you want to use speaker, microphone or programming cable, connect them with this socket. If not, prevent water from dropping into it.

Screen

You can see various icon show on the screen when power on. The following table can help you identification the icon meaning which display on LCD.

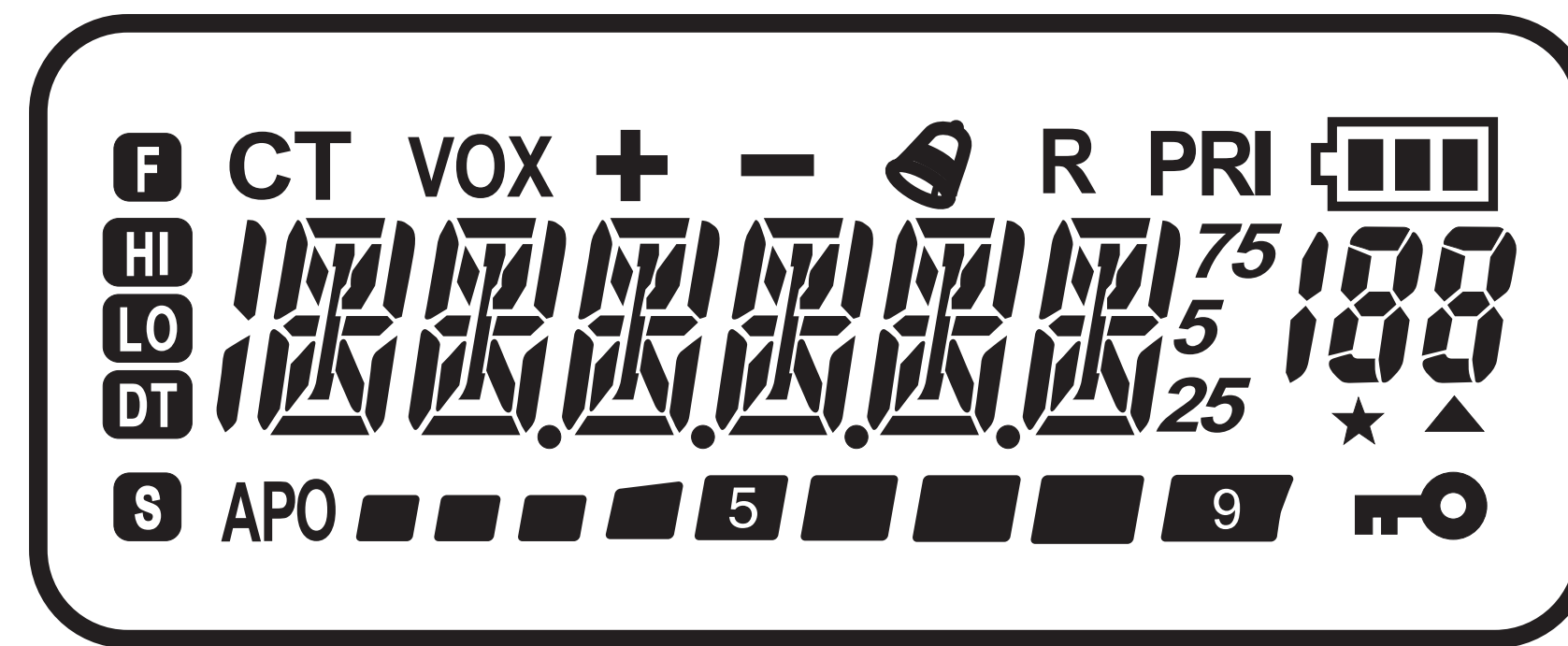

<input type="checkbox"/>		Battery power display
<input type="checkbox"/>		Dispersion to hyper-received frequency
<input type="checkbox"/>		Dispersion to under-received frequency
<input type="checkbox"/>		Frequency scanning indication
<input type="checkbox"/>		Keypad locked
<input type="checkbox"/>		Display when DCS is turned on
<input type="checkbox"/>		CTCSS turned on
<input type="checkbox"/>		VOX turned on
<input type="checkbox"/>		Bell Function
<input type="checkbox"/>		Display reverse frequency
<input type="checkbox"/>		Priority scan active
<input type="checkbox"/>		Received signal strength and power display
<input type="checkbox"/>		Show the working frequency
<input type="checkbox"/>		Function menu
<input type="checkbox"/>		Display when the channel is priority scan
<input type="checkbox"/>		Squelch open

Basic operation

Connected antenna

Insert the base of the attached antenna into SMA connector and coincided with each other by clockwise rotate antenna, make sure the antenna has set down. Take out the antenna from the base by counter clockwise rotation until pull out it from SMA connector.

Turn on and off the power

If you want to turn on the power, rotate PWR/VOL knob by clockwise until beep sound is heard .All icons and frequencies appeared on the screen. (Due to have automatic squelch function, the speaker will not send out any sound before receiving call.) You can adjust your desired volume by turning the button. If you turn off the power, turn PWR/VOL knob in counter clockwise rotation until beep sound is heard .All displays will disappear and the radio is off.

Adjusting volume

After turning on the power, (Due to have automatic squelch function, the speaker will not send out any sound before receiving call.) You can hold down [MONI] key, and then turn PWR/VOL knob to increase the volume in clockwise rotation and decrease the volume in counter clockwise rotation.

Monitoring function

If only hold down [MONI] key and adjust your desired volume by PWR/VOL knob, you can directly hear sound without waiting for receiving any signals.

Transmitting

Firstly, hold down [MONI] a moment to make sure that the channel isn't in busy status and press [PTT] key then speak to the radio in ordinary tone.

Transmitting indicator lighting during holding down [PTT] key.

If you are too close to the microphone or your voice is too loud, it's not clear in receiving.

Release [PTT] key so as to listen a response from your partner.

Emergency Alarm

Hold down [CALL] key for 1 second and press [MONI] key the radio will emergency alarm.

Call to receiver

Press and hold the [CALL] key for 2 seconds .The receiver will ring.

Keypad Lock

In channel/Frequency mode, press and hold down * Lock for two seconds the keypad will Lock. Press and hold down * Lock for two seconds to unlock the keypad.

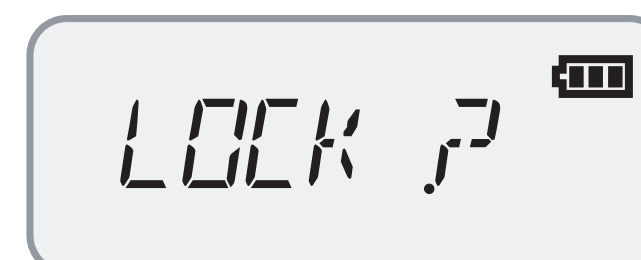

Setting Reverse Frequency Function

In channel/Frequency mode, to select Reverse frequency function, hold down # T-R for two seconds until "R" appears on LCD. To cancel it hold down # T-R for two seconds.

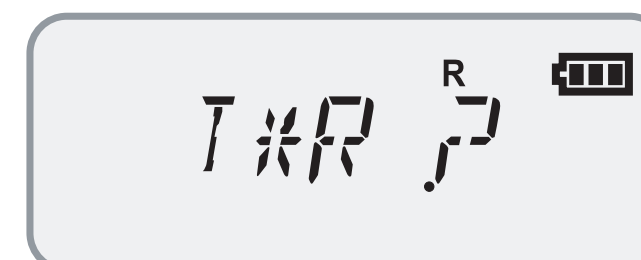

Scanning

Scanning is applicable to monitor your need frequency without manual.

Scan entire channel

In channel/Frequency status, press MENU and 1 SCAN key the radio will scan from current channel through all the channels, whenever any activity is detected, the radio will suspend the scan for 5 seconds. It will then continue to scan unless you press PTT key or ENTER key to end scanning.

Priority channel scan

In Frequency Mode, Press MENU and 2 PRI the radio will scan from current frequency through all the frequency range within 1MHz, whenever any activity is detected, the radio will suspend the scan for 5 seconds. It will then continue to scan unless you press PTT key or ENTER key to end scanning.

In channel mode, Press MENU and 2 PRI the radio will scan from current channel through all the channels, whenever any activity is detected, the radio will suspend the scan for 5 seconds. It will then continue to scan unless you press PTT key or ENTER key to end scanning.

Select scan type

In frequency mode press MENU until display "SCAN 13" and press ENTER . Turn encoder to select. TO/CO/SE

TO: Time-operated scan

After radio lock in a busy channel for a period (the time is set by dealer),the radio will begin scanning other channels even if the channel is still busy.

CO: Carrier-operated scan

Radio will lock in one busy channel until there is no activity, and then radio begins scanning other channel.

SE: Search scan

Radio will lock in one busy channel all the time until you turn the encoder.

DTMF Code

In channel/Frequency status, press PTT and input the number on keypad, MENU stands for A, ENTER stands for B, VFO/MR stands for C, CALL stands for D.

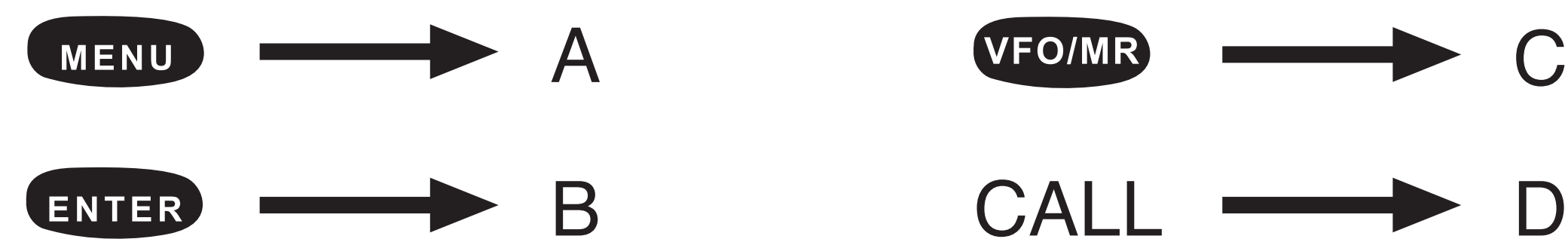

Flank Keys

Moni + CALL : Emergency Alarm, press Moni and call key, Emergency Alarm on

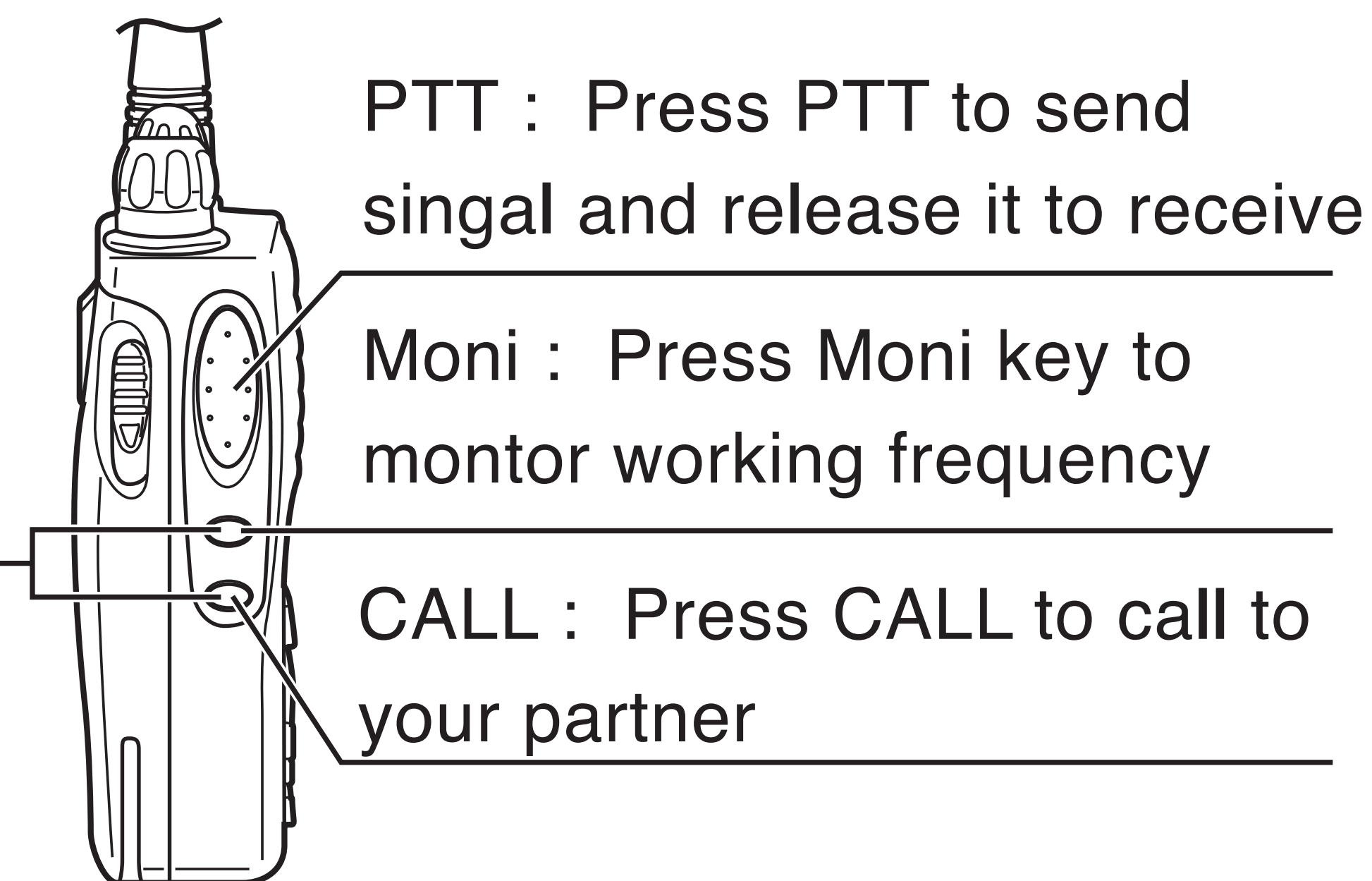

Select Mode

Hold down **VFO/MR** and turn on the power, the radio can switch between channel and Frequency mode.

In Frequency mode, press **VFO/MR** key to switch between. Frequency mode and "CHANNEL + FREQUENCY" (VFO) mode.

Store/Delete

Store

In frequency mode select desired frequency or any other items like CTCSS, DCS. Press **MENU** then press **VFO/MR** key. When one channel number need to store is blinking. Turn encoder or input keypad numbers to store channel number, press **VFO/MR** to confirm and exit.

Delete

1. Delete one store channel

In VFO Mode turn off power.

Hold down **VFO/MR** key and turn on the power. "DEL?" and stored channel number will display on LCD. Turn encoder or input keypad numbers which need to be deleted, press **ENTER** until "YES?" display, and press **ENTER** to delete the channel.



2. Delete all setting of frequency mode

Hold down **MENU** and turn on power until display "RESET?", press **ENTER** until display "VFO?". Press **ENTER** to confirm and delete all setting of frequency mode.

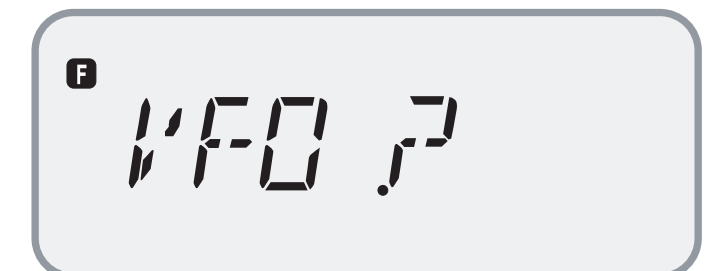
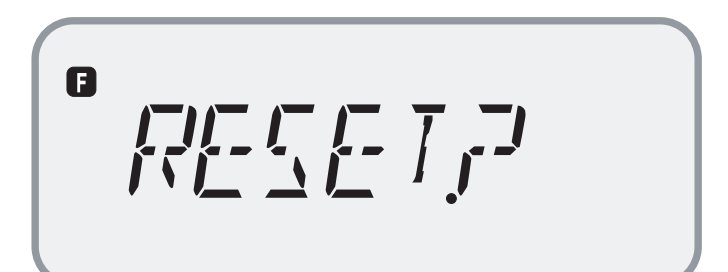

3. Delete all setting

Hold down **MENU** and turn on power until display "RESET?", press **ENTER** until display "VFO?". Turn the encoder to select "FULL?", press **ENTER** to confirm and delete all setting of frequency & VFO mode.



Operation

Select VOX sensitivity level

In channel/Frequency mode, if you want to open VOX, press **MENU** and **3 VOX** then press Enter until "VOX OFF" displays, input the number on keypad (0-9) or turn the encoder to select the sensitivity level, then press **ENTER**. Press **VFO/MR** key to exit. "VOX OFF" set in default factory state.



Setting transmit power

In channel/Frequency mode, hold down **ENTER** and **4 POWER** key then press Enter until "POW L" displays which means Low Power. Turn the encoder until "POW H" appears, it means high power and it is two times than low power. Transmit power level is programmable by using puxing programming software.

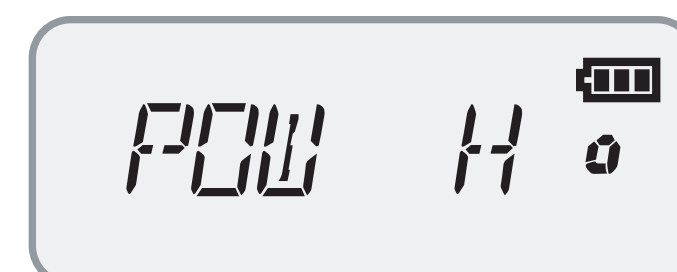
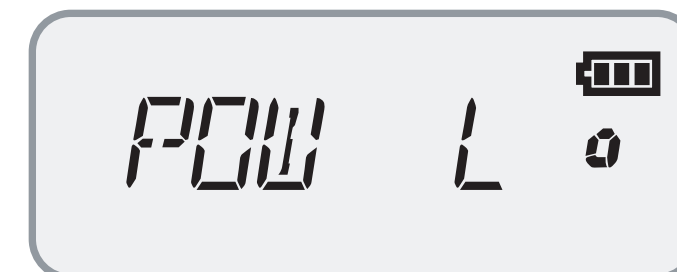

Setting squelch

In channel/Frequency mode, hold down **MENU** and **5 SQL** then press Enter until "SQL 5" displays, input the number on keypad (0-9) or turn the encoder then press **ENTER**. Press **VFO/MR** to exit. "SQL 5" set in default factory state.

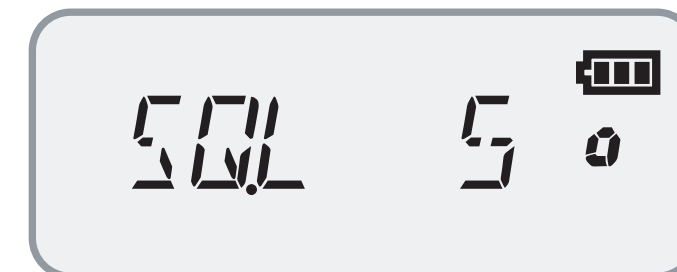

Scrambler on/off

Hold down **MENU** and **6 SCR** then press Enter so that "ON" displays.



Turn the encoder to select ON/OFF then press **ENTER**. Press **VFO/MR** to exit.



Backlight on/off

To turn backlight on. Hold down **MENU** and **7 LED** then press Enter so that "ON" displays, turn the encoder to select from ON, OFF, AUTO and press **ENTER**. Press **VFO/MR** to exit.



Select backlight color

Hold down **MENU** and **8 COLOR** then press Enter so that "LIGHT2" displays, turn the encoder to select one color then press **ENTER**. Press **VFO/MR** to exit. Total three colors are selectable.



Beep on/off

To turn Beep on, hold down **MENU** and **9 BEEP** then press Enter so that "ON" displays. To close Beep turn the encoder until "OFF" displays, then press **MENU**. Press **VFO/MR** to exit.

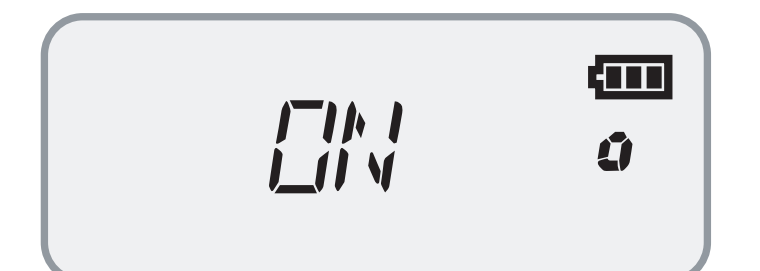

Automatic Numbering Identification (ANI) on/off

To show caller ID on display while the caller press PTT switch. Hold down **MENU** and **0 ANI** then press Enter so that "ON" display, to close ANI please turn the encoder until "OFF" displays, then press **ENTER**. Press **VFO/MR** to exit.



+/- potential difference

In frequency mode, press **MENU** + *** LOCK** then press Enter, turn encoder to select S-D O (same), S-D +(plus), S-S -(minus)

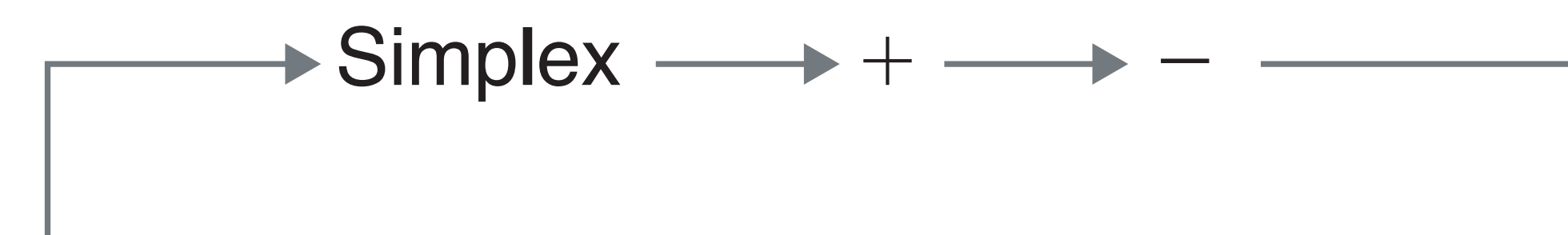
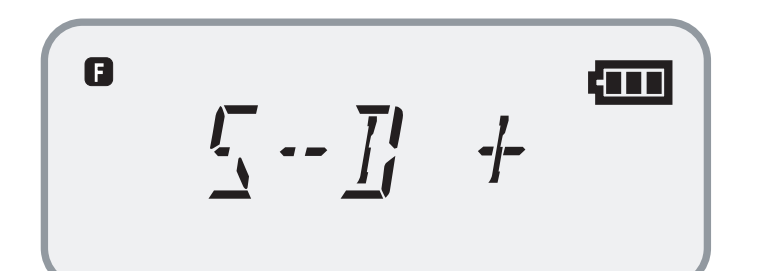
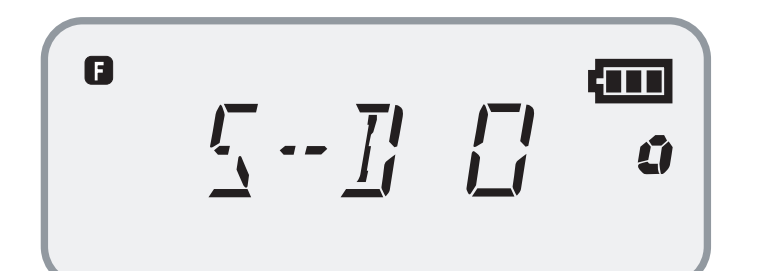
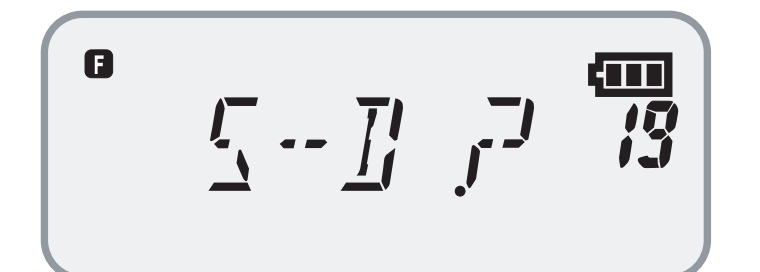

Select beat frequency

This function is used to determine the difference (Potential difference) between sending frequency and receiving frequency.

Press **MENU** key and turn the encoder until "DIFFR ?" displays, press **ENTER** key and input needed frequency, Range from 00.000 to 70.995MHz ,then press **ENTER** key to confirm.



Select frequency stepping

Press **MENU** key and turn the encoder until "STEP ?" displays, press **ENTER** key and turn the encoder to select frequency stepping from 5k, 10k, 6.25k, 12.5k, 25k; then press **ENTER** to confirm, press **VFO/MR** to exit.



Select CTCSS and DCS

In frequency mode, press **MENU** then press **# T-R** and Enter, turn encoder to select desired CTCSS or DCS, press **ENTER** to confirm. (Press *** LOCK** key to switch CTCSS and DCS)

Operation voice

Press **MENU** key and turn encoder to " VOICE? ¹⁴", press Enter to select open or close voice, press Enter to confirm, press VFO/MR to exit optional features in PC software can program the voice in English or Chinese.



Menu Operation

1. Press **MENU** into menu mode.
2. Turn the Encoder to selected menu.
3. Press **ENTER** and turn the encoder to set then press **ENTER** key to confirm.
4. Press **VFO/MR** twice to exit Menu mode.

Menu Operation List

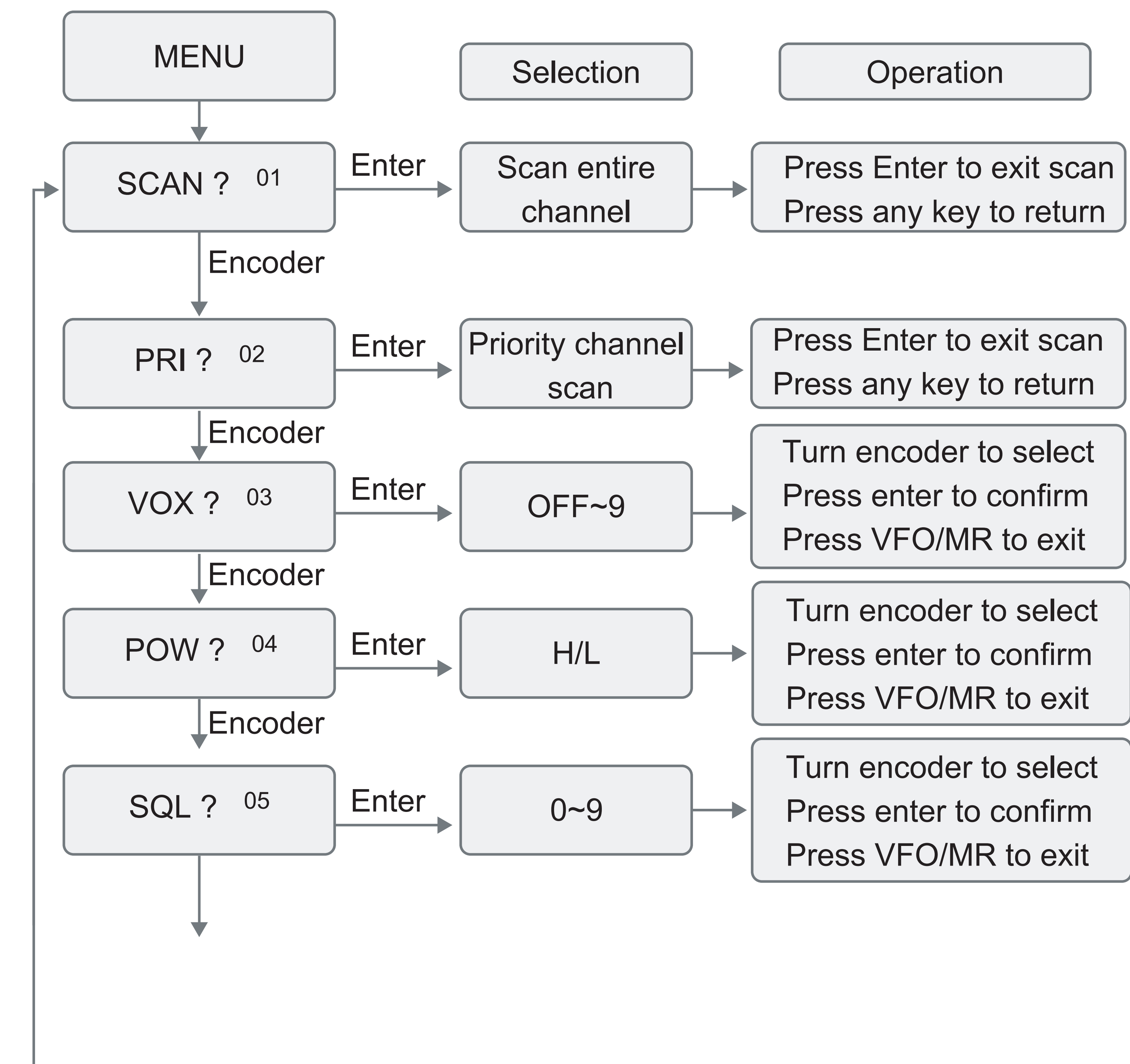

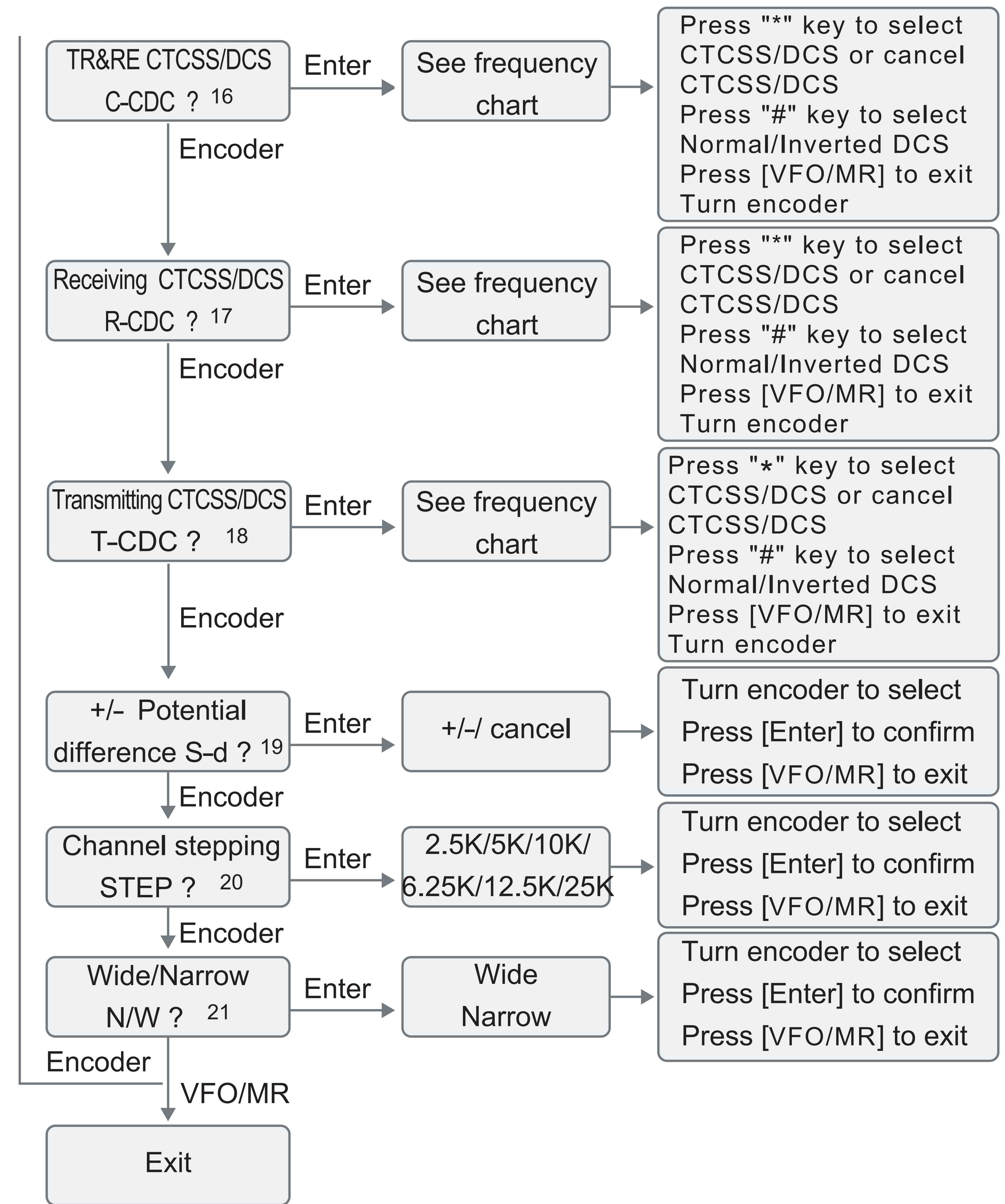
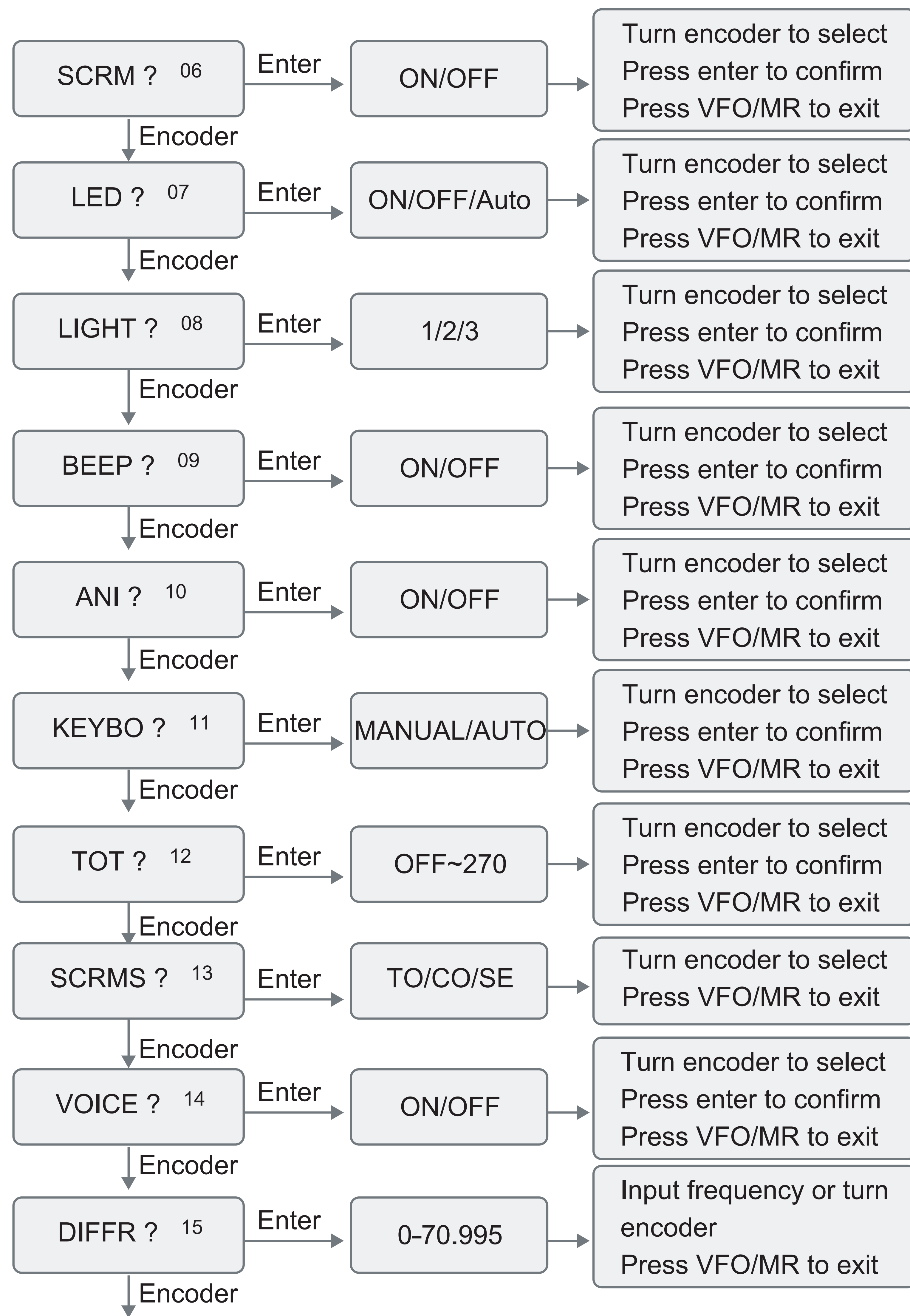

Notice:

1. Items 16-21 is available only in Frequency mode.
2. The item 15 of channel mode.

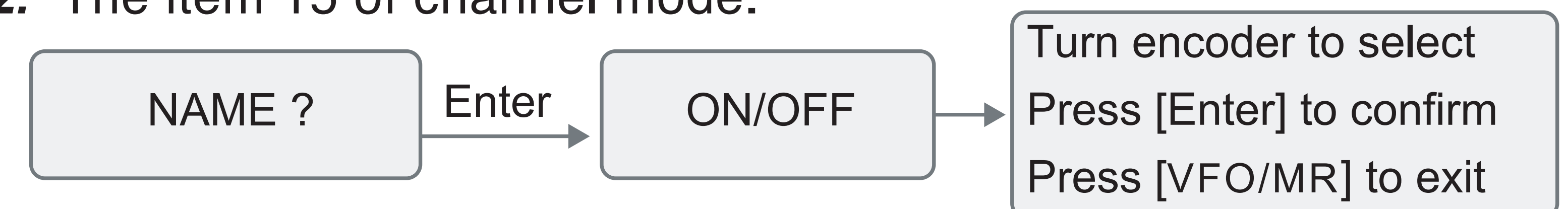

Self-Programming mode

You can set the radio by self-programming.

Operation

- To enter self-programming mode, hold down (MONI) and **MENU** key accomplished by turning on the VOL/POWER switch until "SELF" displays.
- Press Enter key to start.
- Press [ENTER] to store the data and continue to next function.



Items	Display (example)	Contents
Channels Items below are not available if without setting "Channels"		Channels from 1 to 128
Receiving frequency Items below are not available if without setting "Receiving frequency" It will return to "Channels" if "blank" was selected		Blank. (Press VFO/MR)
		67.0000MHz~549.9875MHz Press [CALL] key to select from 2.5K/5k/10k/6.25k/12.5k/25k stepping
Receiving CTCSS/DCS (This item will be skip if without setting "channels")		OFF
		CTCSS (see CTCSS Frequency chart) 67.0Hz-250.3Hz {Notice: (1)}
		DCS (see DCS Normal/Invented chart) 023-754 Normal {Notice: (2)}
		DCS (see DCS Normal/Invented chart) 023-754 Inverted {Notice: (2)}

Transmitting frequency		Same as Receiving Frequency
Transmitting CTCSS/DCS (This item will be skip if without setting "transmitting frequency")		Press * LOCK to select CTC/DCS turn encoder to select
Busy Channel Lockout		OFF: Close: 1: Carrier 2: CTCSS/DCS
Add/Del priority channel scan		Del: Delete priority channel scan Add: Add priority channel scan
Output Power		H: High power L: Low power
Wide/Narrow		Turn encoder to select Press [ENTER] to confirm Press [VFO/MR] to exit
Program channel name		Turn encoder to select Press # T-R to confirm Press enter to exit

Notice

- Set Receiving/transmitting codes
Press *** LOCK** key to select from OFF/CTCSS/DCS

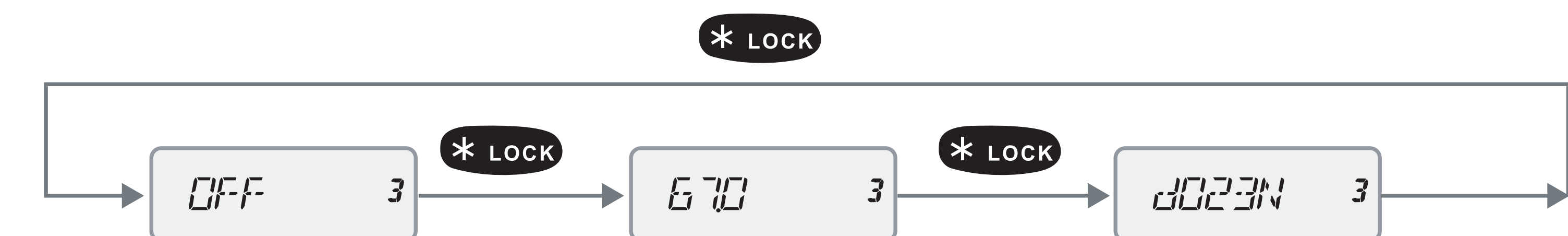

- Press **# T-R** to set DCS Normal/Inverted

Self-programming chart

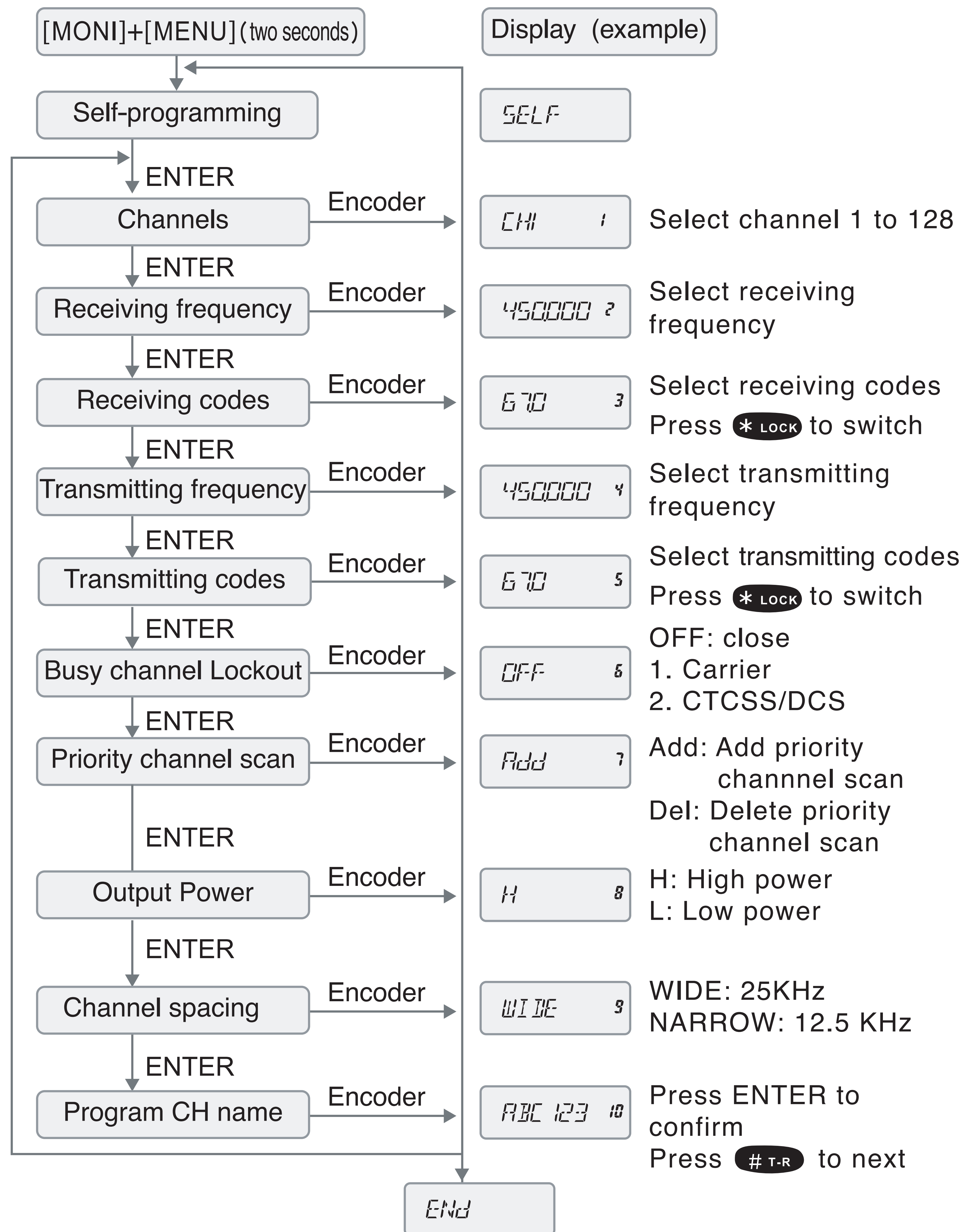

Enclosed chart

50 CTCSS frequency code (Hz)

67.0	85.4	107.2	136.5	165.5	186.2	210.7	254.1
69.3	88.5	110.9	141.3	167.9	189.9	218.1	
71.9	91.5	114.8	146.2	171.3	192.8	225.7	
74.4	94.8	118.8	151.4	173.8	196.6	229.1	
77.0	97.4	123.0	156.7	177.3	199.5	233.6	
79.7	100.0	127.3	159.8	179.9	203.5	241.8	
82.5	103.5	131.8	162.2	183.5	206.5	250.3	

104+1 DCS code

023	065	132	205	255	331	413	465	612	723
025	071	134	212	261	332	423	466	624	731
026	072	143	223	263	343	431	503	627	732
031	073	145	225	265	346	432	506	631	734
032	074	152	226	266	351	445	516	632	743
036	114	155	243	271	356	446	523	645	754
043	115	156	244	274	364	452	526	654	
047	116	162	245	306	365	454	532	662	
051	122	165	246	311	371	455	546	664	
053	125	172	251	315	411	462	565	703	
054	131	174	252	325	412	464	606	712	

Technical specification

General

Frequency Range	136-174MHz 350-390MHz 400-470MHz
Working Temperature	-20℃ ~ +50℃
Operating Voltage	DC 7.2V
Operate Mode	Simplex or Semi-duplex
Dimension	100mm X 55mm X 32mm (Not included Antenna)
Weight	220g (Including battery)
Antenna impedance	50Ω

Transmitter

Frequency Stability	± 2.5ppm
Output Power	≤ 5W
Max Frequency Deviation	≤ 5KHz
Audio Distortion	≤ 3%
Modulation Character	+3dB~-3dB
Adjacent Channel Power	≥ 65dB
Spurious Radiation	≤ 7.5μW
Occupied Bandwidth	≤ 16KHz

Receiver

RF Sensitivity	<0.2μV
Audio Distortion	≤ 3%
Audio Response	+2dB~-10dB
Adjacent Channel Selectivity	≥ 60dB
Intermodulation Rejection	≥ 60dB
Spurious Response	≥ 60dB
Blocking	≥ 85dB

TROUBLESHOOTING GUIDE

PROBLEM	SOLUTION
No Power	<ul style="list-style-type: none"> The battery pack may be dead.Recharge or replace the battery pack. The battery pack may not be installed correctly. Remove the battery pack and install it again.
Battery power dies shortly after charging	<ul style="list-style-type: none"> The battery pack life is finished.Replace the battery pack with a new one.
Cannot talk to or hear other members in your group	<ul style="list-style-type: none"> Make sure you are using the same frequency and CTCSS/DCS tone as the other members in your group. Other group members may be too far away. Make sure you are within range of the other radios.
Other voices (besides group members) are present on the channel.	<ul style="list-style-type: none"> Change the CTCSS/DCS tone.Be sure to change the tone on all radios in your group.